



# ***HI-FLOW FUEL RAIL***

Installation Instructions for part number:

25-130

1989-1999 Mitsubishi Eclipse Turbo 4G63

**WARNING:**

The installation of this Fuel Rail Kit requires the removal and installation of fuel system components. Improper assembly/installation may result in bodily injury or property damage. If you are not qualified to perform this installation, please refer the installation to a professional. Read and understand these instructions before attempting to install this product.

**ADVANCED ENGINE MANAGEMENT INC.**  
2205 126<sup>TH</sup> Street, Unit A Hawthorne, CA. 90250  
Phone: (310) 484-2322 Fax: (310) 484-0152  
[Http://www.aempower.com](http://www.aempower.com)  
Part Number: 10-335

© 2002 Advanced Engine Management, Inc.

Read and understand these instructions **BEFORE** attempting to install this product.

**! WARNING**

- Do not smoke while working on the fuel system.
- Keep open flames or sparks away from your work area.
- Be sure to relieve fuel pressure before working on fuel system.

**1) Getting started**

- a) Make sure vehicle is parked on a level surface.
- b) Set parking brake.
- c) If engine has run within the past two hours let it cool down.
- d) Clean area around the fuel rail so that dirt cannot get into the engine.

**Note it is recommended to:**

- Replace all cushion rings, seal rings and fuel injector insulators when fuel rail is disassembled.

**2) Relieving fuel pressure**

- a) Disconnect the fuel pump harness connector. This connector is located at the rear of the fuel tank on 1989-1994 Eclipses. On later model Eclipses, the fuel pump harness connector is located under the rear seat cushion.
- b) Start the engine and allow it to stop by itself. Turn the ignition key to **OFF**.
- c) Disconnect the negative (-) battery terminal.
- d) Re-connect the fuel pump harness connector.

**3) Stock fuel rail and injector removal**

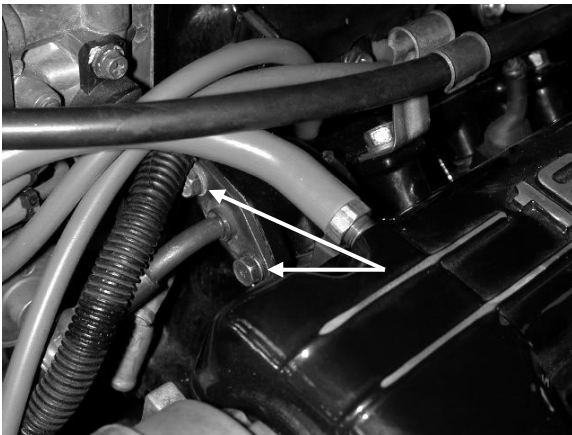

**a)** Remove the two bolts mounting the high-pressure fuel inlet line to the fuel rail. Wrap a rag around the fitting and pull it clear of the fuel rail.

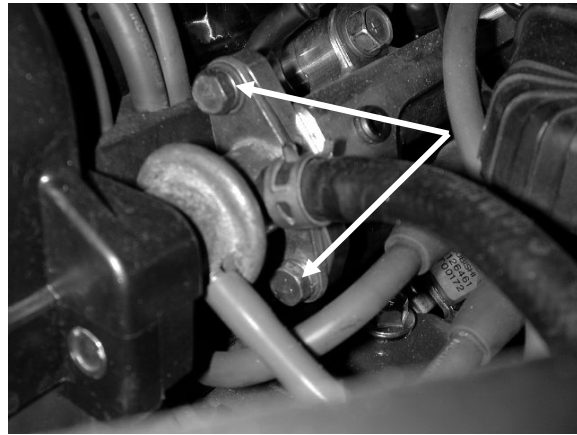

**b)** Remove the two bolts mounting the fuel pressure regulator to the fuel rail. The rail will need to be repositioned before the regulator can be removed due to a lack of clearance with the cam cover.

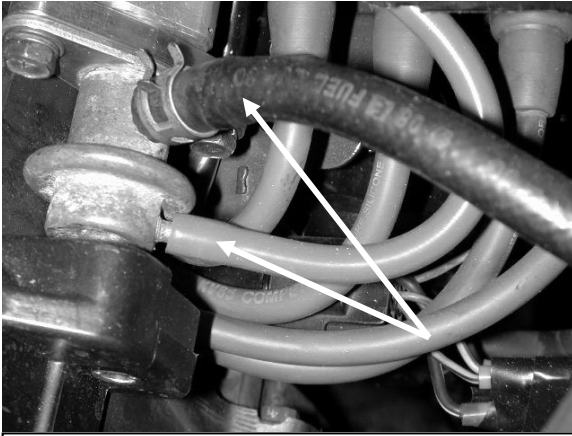

**c)** Remove the fuel return line and vacuum line from the fuel pressure regulator.

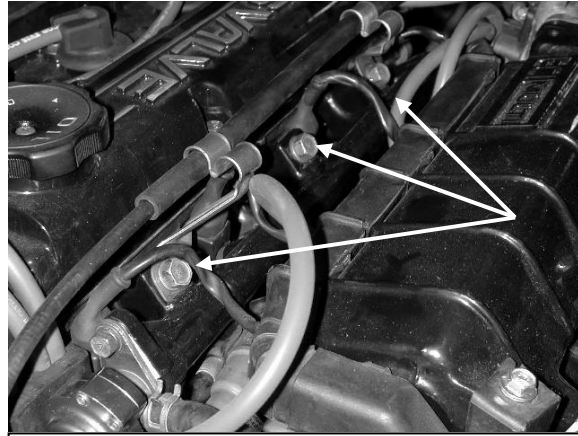

**d)** Remove the three fuel rail mounting bolts. The two outer bolts have throttle cable mounting brackets on them. Removing the throttle cable from the brackets and tucking it out of the way before removing the bolts may simplify removal/installation of the fuel rail.

e) Pull the fuel rail and injectors back from the intake manifold. The injectors should remain seated in the fuel rail.

**Notes:**

- i) **On some models the spark plug wires pass over the fuel rail and impede the removal of the fuel rail. On these models, it is necessary to remove the plastic spark plug cover and to pull the spark plug wires free.**
- ii) **It is not necessary to unplug the wire harness from the injectors. There should be enough space to pull the rail back and turn it upside down to gain access to the injectors.**

f) Remove the injectors from the rail and set the factory fuel rail aside.

g) Remove the three plastic fuel rail spacers. These will not be reused with the **AEM** Fuel Rail Kit.

#### 4) Assembly of the AEM Fuel Rail

**Warning: Improper assembly of the AEM fuel rail may result in leakage. Be sure to pressure test the fuel rail on the vehicle before starting the engine or test-driving. If there is any sign of leakage, the problem must be corrected before proceeding.**

a) Refer to this section of the instructions upon initial assembly of the fuel rail, as well as when replacing the end adapters and o-ring seals.

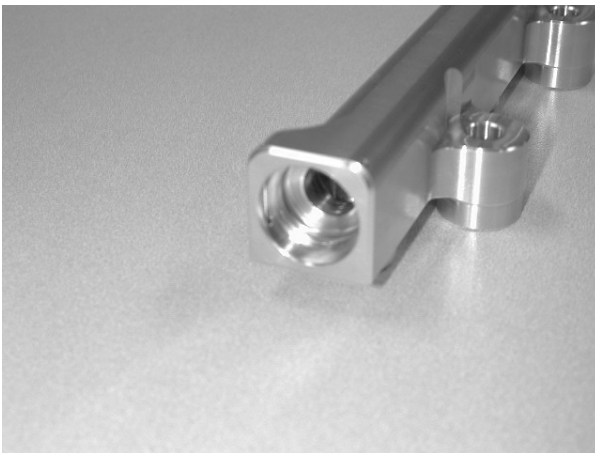

**b)** Make sure both ends of the fuel rail are clean and free of debris and burrs.



**c)** Insert one 1-3024 o-ring into the inner groove. Make sure the o-ring is evenly seated in the groove.

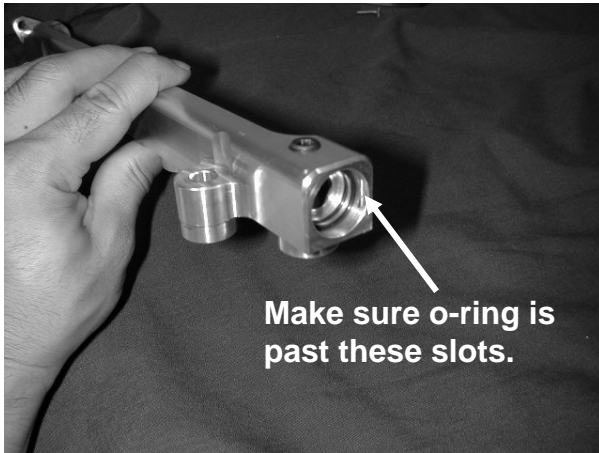

**d)** Insert another 1-3024 o-ring up against the first shoulder. **Make sure the o-ring is seated evenly against the shoulder and is past the slots for the dowel pins.**

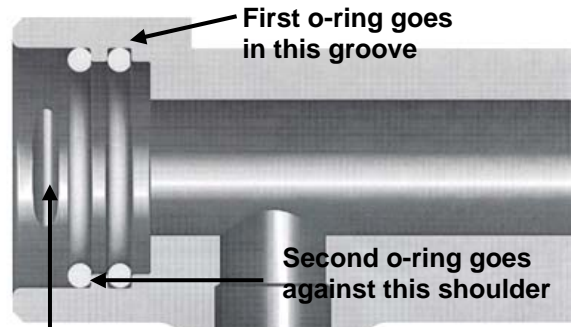

**O-rings *MUST* be past the dowel pin slot**

**e)** Refer to this cut-away view for proper o-ring installation. **Warning: The o-rings *MUST* be properly seated as shown in this diagram. Improper installation may damage the o-rings and cause leakage.**

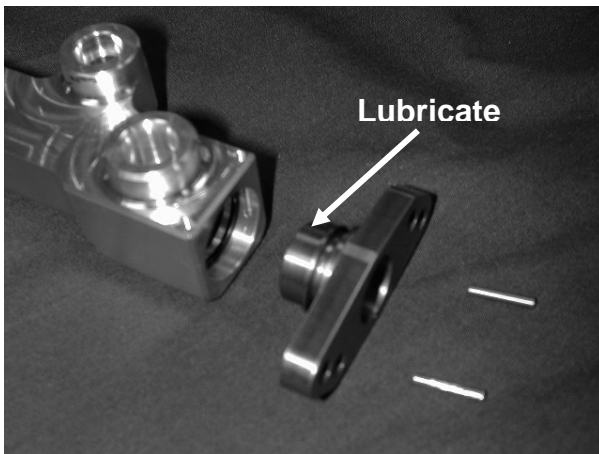

**f)** Lightly lubricate the tip of the end adapter and the o-rings in the end of the fuel rail. Clean engine oil works well.

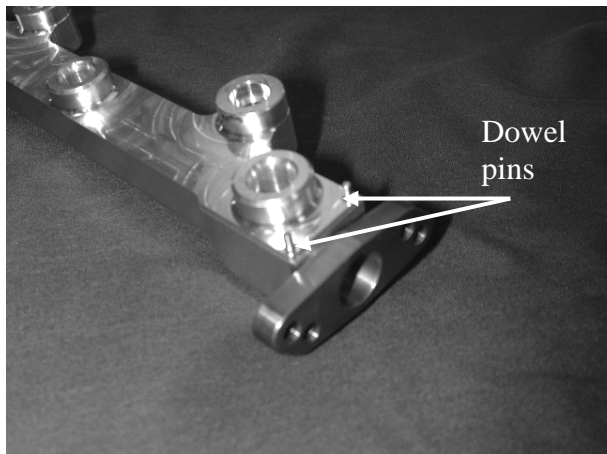

**f)** **Gently** insert the end adapter into the fuel rail. Make sure the o-rings stay in place and are not torn. Insert two 1-2061 dowel pins into the dowel pin holes.



**g)** Insert and tighten two 1-2062 screws into the dowel pin holes. Repeat steps b-g for the other side of the fuel rail.

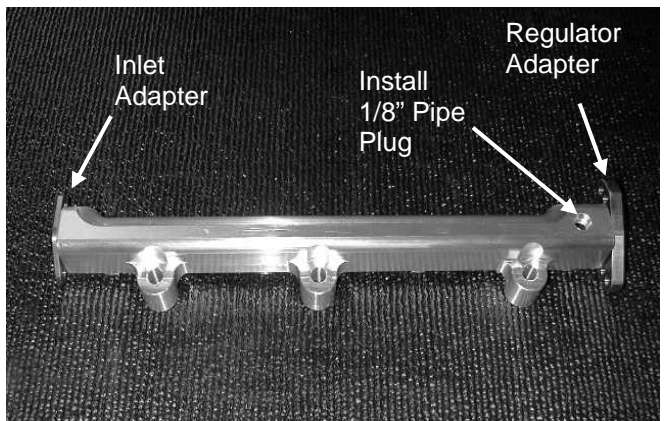

## 5) Installation of the AEM Fuel Rail

- a) Remove the old o-rings that are on top of the injectors.
  - i) Coat the new o-rings, supplied with the kit, with clean engine oil.
  - ii) Install the new o-rings onto the injectors.



**b)** Mount the factory fuel pressure regulator to the **AEM** fuel rail using the factory M6 bolts and washers. The **AEM** fuel rail's regulator flange has been designed to be used with both the 1989-1995 and the 1996-1999 model year fuel pressure regulators.

**Note: Apply a light coat of engine oil to the regulator o-ring before installation.**

- c) Insert the o-ring ends of the injectors into the **AEM** Fuel Rail.
- d) Install the fuel rail/injector assembly back onto the vehicle, using the three supplied aluminum standoffs in place of the factory plastic spacers.
  - i. Be careful to ensure that none of the seals get damaged.
  - ii. Make sure that all seals and o-rings are properly seated.

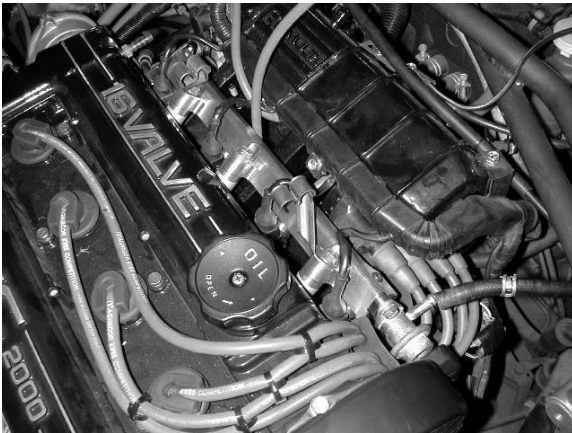

**e)** Install and tighten the three fuel rail mounting bolts. Make sure to reinstall the two throttle cable brackets on the outer fuel rail bolts.

- f) Replace the fuel return and vacuum lines on the fuel pressure regulator.
- g) Mount the high-pressure fuel inlet line to the inlet adaptor on the **AEM** fuel rail, using the supplied M6 x 8mm long bolts and split lock washers.

**Note: Apply a light coat of engine oil to the inlet o-ring before installation.**

- h) The **AEM** fuel rail comes with one additional fuel port. If you are running a wet nitrous oxide system, or a fuel pressure gauge, then this port may be used for the additional fuel supply. If you are not in the need of an additional fuel source install the supplied 1/8" NPT plug.

**Note: When installing the tapered plug or any other tapered fitting into the AEM Fuel Rail, use only a lubricant or anti-seize on the threads. Do not under any circumstances use liquid Teflon or Teflon tape as a sealant for any tapered plug or tapered fitting in any fuel system.**

- j) Replace the spark plug wires (if removed) and any hoses or vacuum lines that were disconnected during installation.

## 6) Finishing Touches

- a) Connect the negative battery terminal.
- b) Turn the ignition switch to the on position for approximately two seconds. **Do not operate the starter.** Then turn the ignition switch to the off position.
- c) Repeat this procedure three times, and then check all components that were removed during installation for any signs of fuel leakage.
  - i. **Be sure to check the area around the fuel inlet fitting, the injectors, the regulator, and the 1/8" NPT plug. If these items were not installed correctly, they may be prone to leakage.**
- d) **If there are signs of leakage you MUST correct the leak before proceeding.**
- e) If there are no signs of leakage, then start engine and again check for leaks. If there is any sign of leaking you **MUST** repair the leak before driving the vehicle.

**For Technical Inquiries  
Please E-Mail us at  
tech@aempower.com**

### Bill of Materials for Kit # 25-130

Qty.	Part Number	Description
1	2-5130	Mitsubishi 4G63 Fuel Rail
1	2-643	Mitsubishi Fuel Rail Inlet Adapter
1	2-644	Mitsubishi Fuel Rail Reg. Adapter
3	2-642	Mitsubishi Fuel Rail Standoff
4	1-3024	O-Ring (BUNA 70)
4	1-2061	3/32" x 5/8" Stainless Dowel Pin
4	1-2062	5-40" x 1/4" Fillister Head Slotted
1	1-121	1/8 Pipe Plug
4	1-3008	O-Ring, Fuel Injector Seal
2	1-2060	M6x1.0 8mm Long Bolt
2	1-3025	M6 Spring Washer
2	10-922S	Decal, AEM Large Silver
1	2-5130	Mitsubishi 4G63 Fuel Rail
1	10-335	Instructions